



ARKBIRD is a high-accuracy autopilot designed for fixed-wing. It can superimpose OSD (On Screen Display) data on videos and at the same time control the balance, the return and many other maneuvers of your aircraft with high precision.

The perfect auto-stabilization system and a plug-and-play design free you from worries and inconveniences and enjoy the beauty of FPV in an instant.

Arkbird OSD 2.0 Includes:

1. High accuracy air-speed meter; with air-speed and ground speed control and protection.
2. New design of shell and internal framework; double CPU; flight performance optimized.
3. High-definition OSD menu with graphical scrollable fighter interface. Menu and flight interface has Chinese version.
4. Integrated AAT airborne module which can cooperate directly with the ground terminal of Arkbird AAT.
5. 7 input channels and 7 output channels; with stability augmentation output on the PTZ.
6. Flap can be intelligent controlled by speed , channel1-7 (aileron-flaps) mix-control selectable; with slow release function, flap value can be displayed on the OSD.
7. More ways of mixed control include delta wing and V-tail wing, and Bi-motor plane, Bi-motor flying wing and butterfly brake (mixed control of 1247channel).
8. Analog RSSI port and PPM port; support Arkbird 433 10channel+RSSI single wire transmission.

8 Basic functions Escorts your flight

1. Function all in one board, on board IMU (Inertial measurement unit), OSD (On Screen Display), barometer Attitude sensor, 12V-5V regulation chip, "ESC + voltage regulation" dual power supply. Industrial reliable designed.
2. Plug & Play design, no needed to weld any wire.
3. Can be installed flatwise or sidewise, suitable for small aircraft.
4. Intelligent PID controller. Easy to adjust.
5. Adjust parameters by OSD menu and radio stick.
6. Power & Video voltage, Go-home direction, radar mark, flight time, horizon, total distance, and power consumption, etc, can be displayed on Screen.
7. One button auto-leveling, stick back to center, plane can fly levelly.
8. One button RTH (return-to-home), lost radio signal return-home.

10 Extended functions Meets all you need

<u>Launch Assist</u>	Run up with aircraft in hands, when the speed is higher than 5kmph, the throttle will start output and automatically control the take-off.
<u>Fence mode</u>	Out of rectangle area or safe height, it returns automatically, best helper for beginner
<u>Waypoint Mode</u>	It is able to trace the Way Point Set by menu.
<u>Hover mode</u>	Regard the hover position as balance position, nose up and keep steady
<u>Cruise flight</u>	Keep a straight & constant-height flight.
<u>Flap control</u>	Lower the flap surface automatically when speed is insufficient.
<u>Butterfly brake</u>	Mixed control Make the fly wing change its direction smoothly without aileron inclining
<u>Flight Record</u>	Records the time, voyage, data of power consumption and various maximum records of the flights.
<u>Gyro Mode</u>	It will do compensation for unintentional attitude changes to keep 3D angle status.
<u>PTZ output</u>	When the flight is tilting, channel 5&6 will give an opposite compensation, so as to level the camera.

(Note : Press Ctrl+ F to search the document for a specified function)

Attention



All the details can be found in our instruction. Please read carefully before operating and pay close attention to the details and important parameters, in case you miss any important information which may leave hazards or cause damage.

Reminding:

For the first installation, please power up after a **wire check**. Forcible satellite search interface will be entered (incontrollable) every time you power up. You can pop-up manually and adjust rudder angle directions in **Manual Mode** and **auxiliary control** in Balance Mode. A **Neutral Point Check** for the sensor is necessary. Also, you need a **fail-safe protection** for the receiver in case your autopilot loses control when returning home. Adjust the OSD voltage value before takeoff.

For the first flight, we suggest taking off with "Manual Mode". Check if the aircraft flies normally after switching to "Balance Mode" in a level flight. Then switch to "RTH Mode" and check the autopilot by using OSD parameter (see the last chapter in the instructions: **Notes for Balance and RTH**). Please keep an eye on the important parameters during the flight (Vibration value, Satellite number, Speed and Altitude).

When the maiden flight test is done, Balance Mode can be used freely for taking off the autopilot, or you can use extended functions such as waypoints, cruise flight or fence mode.

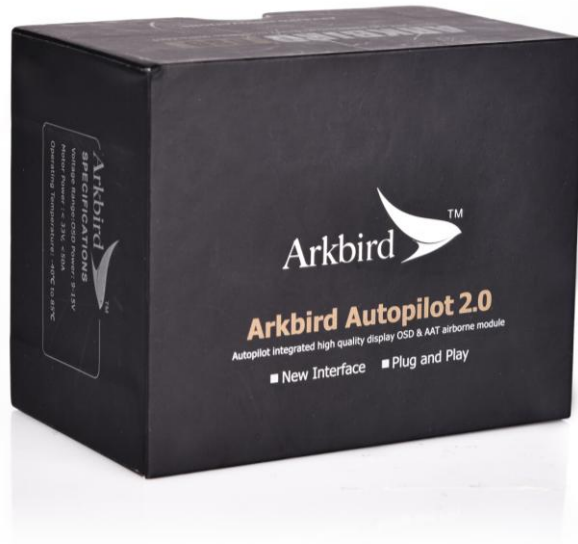

CONTENTS

1. Wirings	4
2. Power Supply Mode	6
3. 5V Dual Power Supply	8
4. Installation	8
5. Switch Modes through CH5 and CH6	10
6. GPS&Save Home Position	11
7. Manual Mode	12
8. Fail-Safe to RTH mode	13
9. OSD and Menu	14
10. Balance Mode and RTH Adjustment	11
11. FAQ and Solutions	23
12. Other FAQ	23
13. Attentions	24

1 Wirings

Attention:

Make sure connect according to the marked order of - + S. The black wire is the ground wire. It is close to the upper side. The signal wire below is for the yellow socket. Check all the wiring before power on. Don't mistaken 12v and 5v so as not to cause damage to the equipment.

If your need to use RSSI function, please connect AIRSPEED METER on RX port, RSSI connect AR port.

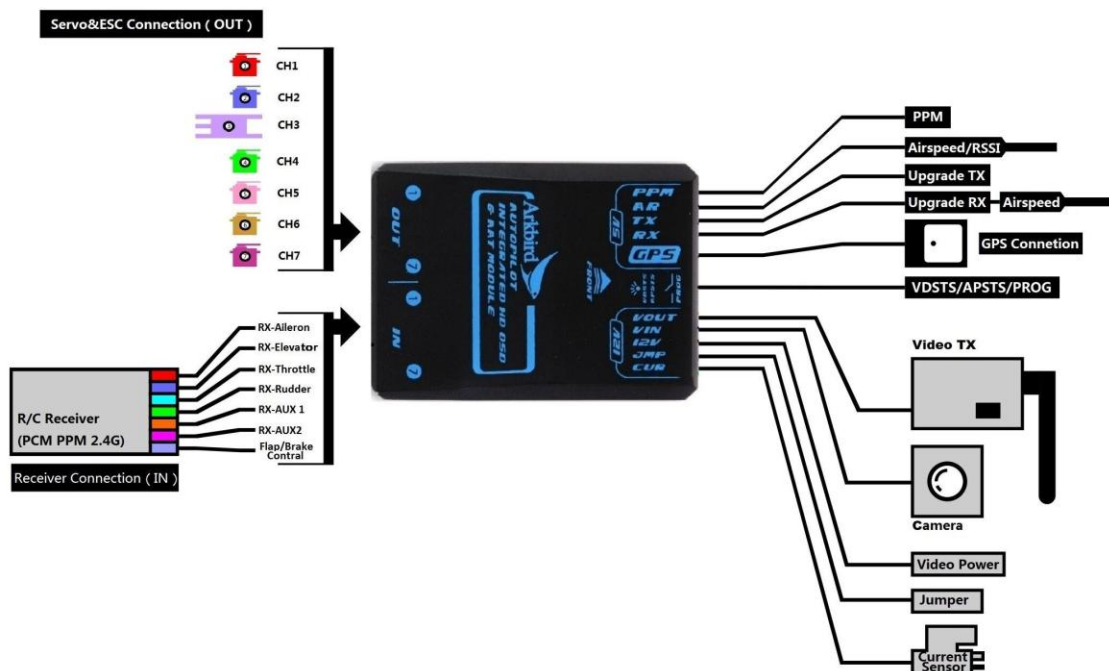

Mixed control output

Arkbird 2.0 provides various intelligent mixed control

	Ordinary	Fly-Wing	V-Tail	Bi-motor	Bi-motor Fly-Wing	Butterfly Brake
CH 1	Aileron Y	Right surface	Aileron Y	Aileron Y	Right surface	Left-Outer surface
CH 2	Elevator	Left surface	Right V-Tail	Elevator	Left surface	Right-Inner surface
CH 3	ESC	ESC	ESC	Left ESC	Left ESC	ESC
CH 4	Rudder	Rudder	Left V-Tail	Right ESC	Right ESC	Left-Inner surface
CH 5	Gimbal Roll	Gimbal Roll	Gimbal Roll	Gimbal Roll	Gimbal Roll	Gimbal Roll
CH 6	Gimbal Pitch	Gimbal Pitch	Gimbal Pitch	Gimbal Pitch	Gimbal Pitch	Gimbal Pitch
CH 7	Flap Y*	Flap Y*	Flap Y*	Flap Y*	Flap Y*	Right-Outer surface *

- 1) When connecting CH7 to two Flap servos with a Y shape wire, you need a inversed servo, but when connecting Butterfly Brake, there is no need using a inversed servo.
- 2) You can use CH1/7 mixed control, using two surfaces to achieve aileron & flap functions.
- 3) If you are using AR port as RSSI, you can also connect Airspeed sensor to RX port.
- 4) Bi-motor mixed control, when throttle is less than 25%, there is no differential steering, when over 25%, throttle outputs differential steering.

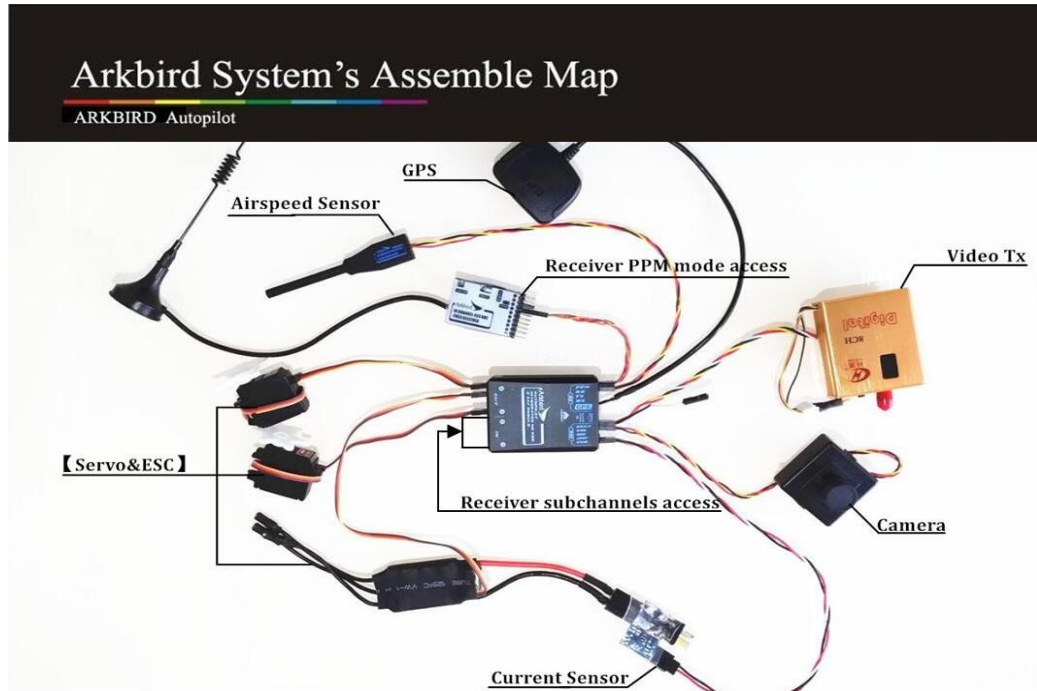

Attention:

1. If the camera needs a 5V supply, please connect a BEC from 12V or main power. Do not connect CPU 5V for a 5V camera in case of the power supply shortage.
2. Connect Receiver's CH1-7 to IN PORT or use a PPM connection. PPM interface supports Arkbird 433 receiver to achieve single-wire 10 Channel transmission and signal strength RSSI (automatically identified when plugged in).
3. The digital high-accuracy airspeed meter of Arkbird 2.0, can calculate the relative speed between the plane and air, which is different from GPS ground speed. As the air speed is a necessary condition for generation of lift force. Insufficient airspeed may cause stall. The airspeed meter collects the speed in front of the plane. As to flying in windy days or when flight is heavy-loaded, it will increase throttle when flying upwind and decrease when flying downwind.
4. Extension wire can be used. Do not make the orifice get close to the motor so as to avoid airflow interference. After power on, it will be calibrated automatically within 10 seconds. During this period, do not touch the orifice.
5. When the airspeed meter is connected, the OSD will display the airspeed A 0km/h. Under the RTH and waypoint mode, either air speed or ground speed is lower than the set "safe speed", Autopilot will increase the throttle proportionally.

Attention: The airspeed meter only participates in control under the mode of returning or waypoint etc. Under the balance or manual mode, it does not participate in control. In this time keep an eye on the value on the airspeed meter for reference.

2 Power Supply Mode

Recommend using one single 3S (12V) battery to supply motor power and Arkbird OSD, Video TX & camera (Shared supply),

Otherwise, use one battery (4S-6S) to supply motor power, another 3S battery to supply OSD & Video (Separated supply).

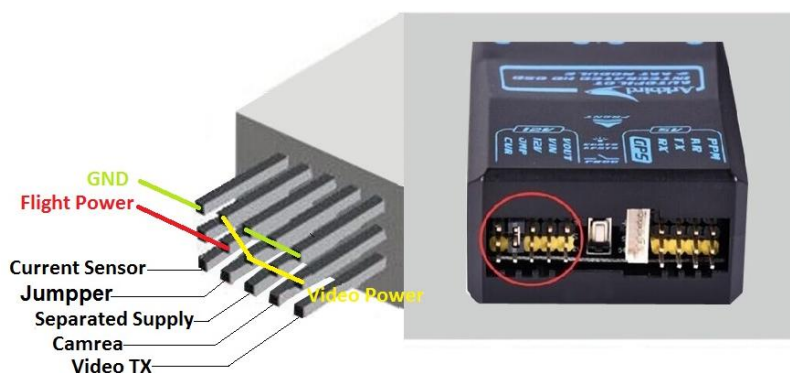

3S Battery Shared Power Supply (Factory Default)



Current sensor's 3P wire wires in the **motor power**. Flight Power port is only for voltage display and have a maximum input of 33V.

1. If 3S battery, plug in the jumper (Default), it will supply power to **12V Video system** (Arkbird OSD, Video TX & camera).

Arkbird OSD(from **Video Power**) supports Maximum voltage of 17V, but notice that most video TX and camera is 12V max, so we have to use a 3S battery.

If Using 4S(16.8V)battery, and the Video TX and the Camera can work under the input of 4S (17V), you can also use this connection methods without worrying damage to the Autopilot.

Independent Power Supply



2. If separated supply, remove the jumper, connect another 3S battery (800mah-1400mah) to the Video Power Port (12Vin) on the third row.

Schematic drawing of Independent Power Supply Wiring



(You can also choose the new Arkbird current sensor with 12V regulated output (accessories) which shares one battery with motor and the video sector.) Please see as below :



Note:

When using 4S-6S battery, connect jumper cap on the regulator current sensor to ">3S" (Default connection), the output voltage of white line is 12v at the moment.

When using 3S battery, connect jumper cap to "3s=POW", regulator module will not work at this time, the output voltage is Power voltage of your 3S battery.

3 5V Dual Power Supply

On board OSD 12V to 5V regulator, with 5V BEC (form ESC) supplies power to the CPU module at the same time.

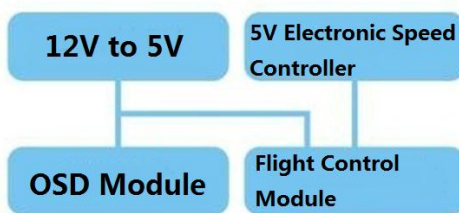

If OSD function is not used, please plug in OSD 12V power as well to prevent a lack of power supply for 5V electronic speed controller.

4 Installation:

1. The pins of GPS and 12V ports shall stay forward (toward flying direction); the side with Arkbird LOGO shall be upward or vertical toward right wing. (Default is level installation)
2. Keep GPS antenna upward placed and away from interference sources such as VideoTX and camera.
3. Put on heat-shrink tubing, fix by sponge and cable tie. Please keep away from motor to avoid vibration which will reduce the accuracy of sensor.
4. When setting return-to-home, please take off propellers for safety concern.

Level Installation



Vertical Installation

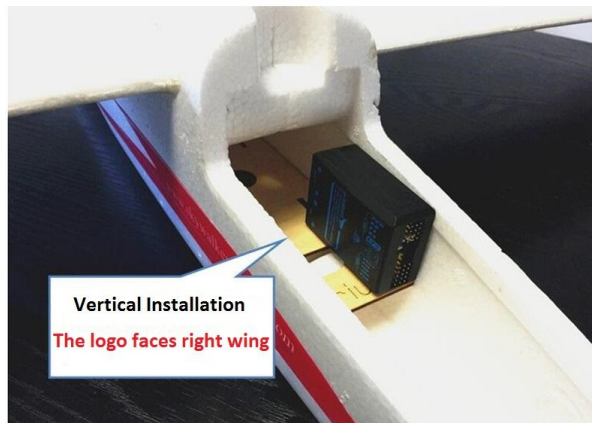
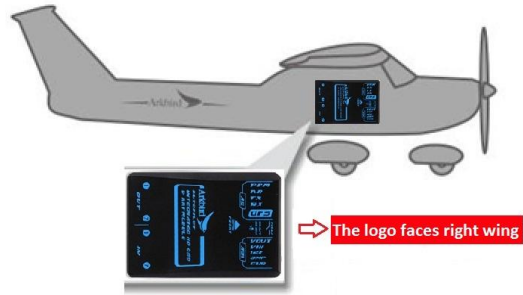

2 ways of installation

5 Switch Modes through CH5 and CH6:

After installation, test OSD and the radio control. Use CH5 and CH6 (0% to 100%) to switch flight mode.

- While CH5 < 50%, it switches to **Manual Mode**, autopilot is not involved in the control.
- While CH5 > 50% and CH6 < 30%, it switches to **Balance Mode**;
While CH5 > 50% and 30% < CH6 < 70%, it switches to **Custom Mode**(Waypoint Mode ,Hover Mode, Fence Mode, RTH mode), Default is RTH mode.
While CH5 > 50% and CH6 > 70%, it switches to **Return-to-home (RTH) Mode**.

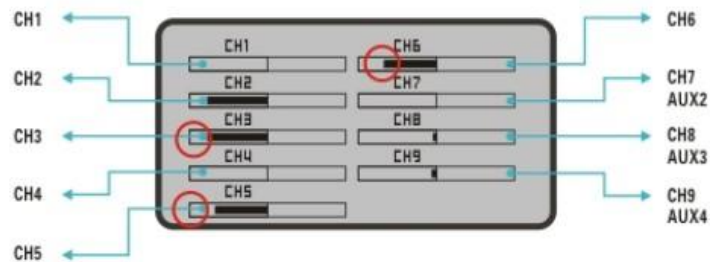
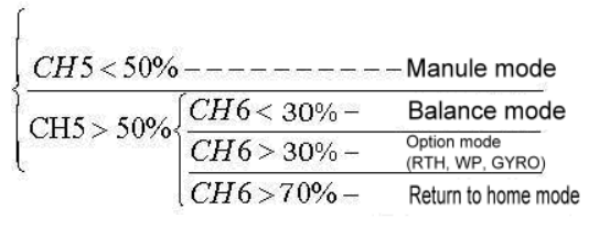

6 GPS & Save Home Position

After power on, Arkbird will start to search GPS satellite and save the first valid position as Home.

During searching, the elevator will be up and any manipulation of radio stick is invalid. If need to skip the searching, please push CH6 more than 75% and push CH1 to left or right side for 1 second.

Once skipped the searching, it **CANNOT** switch to RTH mode, **RTH logo will flash** but it is balance mode.



The plane cannot be manipulated when forcible satellite searching

Flight OSD Interface

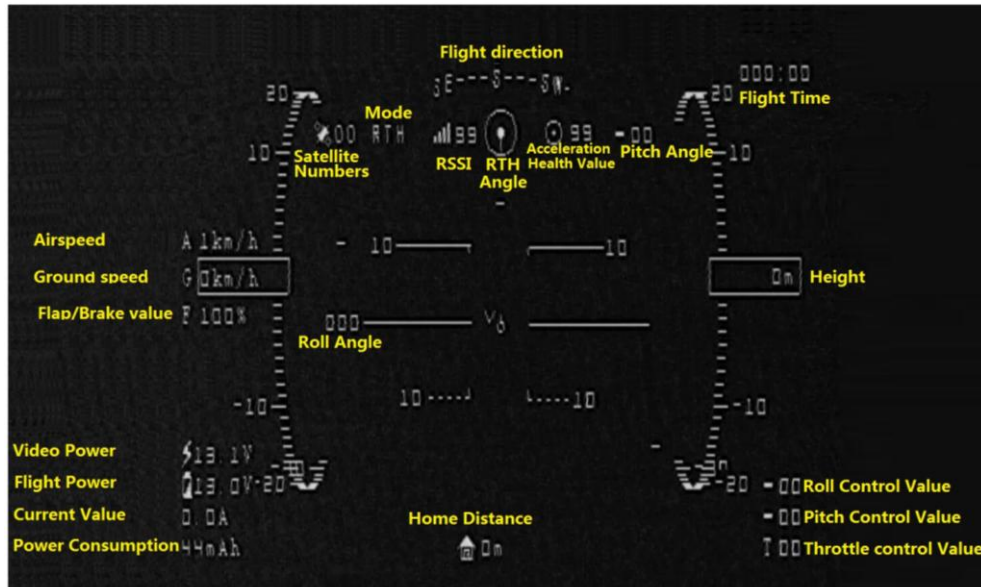

Attention

1. Only when the camera signal is connected can the OSD work and the AAT function be used; when no camera connected, the VDSTS yellow LED flashes slowly. Upon receiving, the LED will flash fast.
2. There is AAT modulation module in the Arkbird OSD 2.0. The GPS information is superimposed in the video signal, and can be downloaded via video TX unit. Together with the ground unit, GPS signal can be directly identified and tracked. (AAT ground terminal's yellow LED has double flash lights at first. After being positioned, the yellow LED flashes fast. As there is no audio output, the green LED will not flash). **if VDSTS**

on OSD2.0 or the ground terminal's yellow LED does not flash, try to change the PAL/NTSC format. When applying NTSC, AAT ground module may need to upgrade.

3. Please reduce the motor vibration to keep the “**vibration value**” more than 70 (99 is the most ideal situation).
4. The idle current is 0.8A while turning off the throttle, if the readout is wrong, please enter the OSD menu and exit to reset the current value.
5. When Arkbird is auto piloting the plane(RTH mode、Cruise flight), **the lower right will display Roll, Pitch control Angle Value and Throttle Value**, Adjust Autopilot if these angles not appropriate.
6. Pay attention to GPS satellite quantity, less than 7 will result mistake positioning.。
7. As Arkbird applies anti-interference inertial navigational compass, instead of magnetic compass, there is no need to do manual calibration. But the flying direction on the compass is incorrect on the ground. 10 seconds after taking off, it will calibrate according to the GPS coordinate. Then compass gets normal.
8. The horizontal position should be identical with the actual horizon. If not, calibrate the sensor again.

7 Manual Mode

Radio Stick and SUB-TRIM back to center, set radio travel range as 100%.

Switching to **Manual Mode**, Arkbird will not participate control, set **manual control's reverse** through radio, adjust plane's CG and travel angle, make sure plane can fly stably in horizontal without Autopilot.

Reverse Balance Mode assistant Control

Switching to **Balance Mode** by pushing CH5 to 100% and CH6 to 0%, if the neutral point is correct, rudder, aileron and elevator shall be at the neutral position, otherwise, please check the neutral point again.(see OSD menu -> CTL parameters)

1. **Aileron**: When rolling the plane to right, aileron shall produce a left compensation automatically, make plane go back horizontal. On the contrary, when rolling to left, aileron will produce a right compensation. Please see as below:

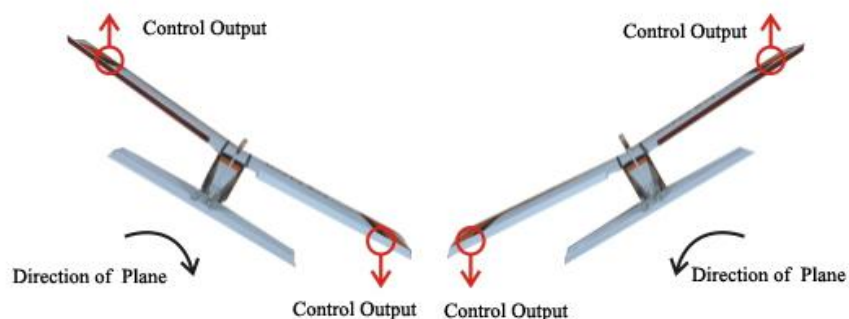

If the compensation direction is not correct, please adjust the Roll inverse in OSD menu -> Flight parameters.

2. **Elevator**: When pitching up the plane, elevator shall produce a down compensation automatically. On the contrary, when pitching down, elevator will produce an up compensation. Please see as below:

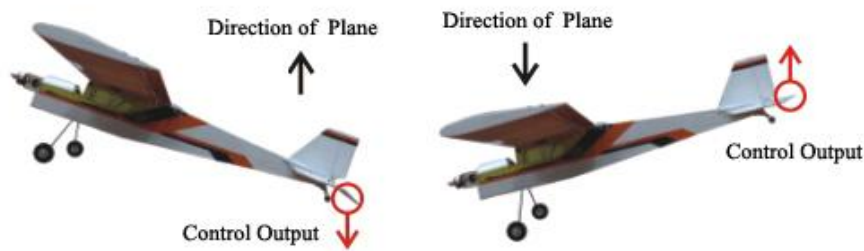

If the compensation direction is not correct, please adjust the Pitch inverse in OSD menu -> Flight parameters.

3. **Rudder:** When yawing the plane to right, rudder shall produce a left compensation automatically. On the contrary, when yawing to left, rudder will produce a right compensation.



If the compensation direction is not correct, please adjust the Yaw inverse in OSD menu -> Flight parameters.

If using Mixed-control, check the compensations for a leveling flight, pay attention to differential steering speed if using Bi-motor control.

7 GPS and Return to Home Instruction

While switching to **RTH Mode** (CH5 to 100% and CH6 to 100%), it will adjust the flying height to safe height to go home.

If the **throttle safe** is open and **when height and distance is within 30m**, there will be no throttle output, to avoid any hacking while adjusting. (Refer to OSD menu)

During RTH mode throttle will increase if altitude is low, or speed is slow, decrease if altitude is high, or speed is faster than set safe speed.

Once lost GPS satellite, switching to RTH, the plane will **go home automatically based on the home angle of last position before out of signal**. Within radio range, please switch to Balance Mode and land.

Please keep an eye on the quantity of GPS signal and voltage value, fly carefully. Please note if the quantity of satellite is less than 7, the positioning might not be correct.

8 Fail-Safe to RTH mode

Fail-Safe is a **receiver's function** to preset position when receiver is out of signal. Some receivers can set in the radio menu, and some save the current position through receiver (probably through a button).

Please refer to the manual of receiver. Set the fail-safe position the same as Return-to-Home Mode through CH5 and CH6 (CH5>50%, CH6 > 70%). And then turn off the radio to check if it switches to Return-to-Home Mode.

(Note: No need to set fail-safe from channel 1 to channel 4 as these four channels are controlled by autopilot under Return-to-Home Mode, which is not relevant to receiver.)

9 OSD and Menu

CH5 switches to Manual Mode(<50%), throttle to 0%, and push CH1 to left or right side for 6 seconds, it will enter into main menu. Exit the main menu if CH5 switches to auto mode(>50%).

Moving stick up and down to change the value, pushing to right side to select, and pushing to left side to exit and save parameters.



Main Menu:

Set HOME	Save home position
Set CTL Parameters	Set CTL Parameters
Set RTH Parameters	Set RTH (Return to Home) Parameters
Set OSD Parameters	Set OSD Interface

Flight Parameters	Reverse and delta-wing mixing
Fence Area Set	Set Fence Mode Area
Way Point Set1	Set Way Point Mode1
Way Point Set2	Set Way Point Mode2
-Flight Record-	Records of flight time, curding range, power consumption and every highest record. "RECENT" refers to the recent flight record: "RECORD" refers to the total record.
Reset All to Default	Move stick to right side for 5 seconds to reset to default

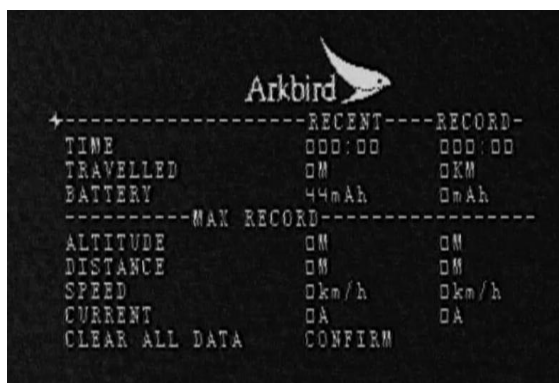

Flight Data Logging Function

Set CTL Parameters



Roll Ctl	Roll Control(%) (equivalent to travel range on radio, Please adjust the travel range on OSD, do not adjust through radio)
Pitch Ctl	Pitch Control (%)
Yaw Ctl	Yaw Control (%)

Neutral Check Neutral Point Check:

Neutral point alignment needed under first installation, not used for weeks, or temperature variation is more than 10 degrees.

Aileron **all the way to the right** means it is waiting autopilot be put down, OSD shows "Waiting Neutral Point Check."

Put the autopilot paralleled to the ground (Please prop up if there is a landing gear), and **move CH1 left and right** to do 3-seconds neutral point check. Aileron will be back to center once finished.

Note: **Pushing CH5 and CH6 to minus (0%) and moving CH1 stick to left or right side** within 3 seconds after power on can also enter neutral point check.

Launch Assist

After turning the function on (ON), "Launch Assist" function which can help to control throttle and reduce the difficulty of take-off in manual throwing process.

Switch to balance mode and the throttle will not be started.

Run up with aircraft in hands, when the speed is higher than 5kmph, the throttle will start output and automatically control the take-off.

Note: This function can only be started when more than **6 GPS satellites** are available. In order to ensure safety, in run-up process, lower the throttle stick, lower the aircraft head down 35° or stop the run-up, throttle will be disabled. When the aircraft flies above 15m high, or more than 100 m away, launch assist will be disabled and throttle will under normal control.

Custom Mode

Custom Mode(CH5 > 50% and 30% < CH6 < 70%):

RTH : Return to Home(Default)

Way Point : Way Point Mode, it is able to trace the Way Point Set by WayPoint menu.

HOVER : Hover mode, regard the hover position as balance position

Gyro : Gyro Mode, it will do compensation for unintentional attitude changes.

Hover Elevate Switched to Hover mode, the plane will nose up , if the plane cannot maintain front/backward position ,increase this value so the elevator surface will move up a little angle (nose down).

Lock Dir/Heig Lock direction and height (Cruise flight):
ON : Under balance mode, when CH1 and CH2 stick back to center, height and direction will be locked and keep straight & constant-height flight.
 Aileron and elevator can also be controlled through CH1 and CH2.
OFF: Turn off the mode.

Set RTH Parameters



Max Roll Max roll angle while return to home, 20 to 40 degree recommended.
Max UP Max pitch (up) angle while return to home, 20 to 40 degree recommended.
Max Down Max pitch (down) angle while return to home, 20 to 35 degree recommended
Elevate Angle Level flight's elevate angle, 3 to 15 degree recommended. Please adjust this value while pitch up or down to have level flight even the stick is back to center.

RTH Throttle Return to home throttle (%)
AUTO Throttle The autopilot will use the throttle value of level flight automatically as return to home throttle. (Default)

Safe Speed Minimum speed of return to home (when speed is less than the certain value, it will accelerate throttle in proportion to avoid lost while being upwind.)
Safe Height Safe Height (The minimum height of return to home, 80 to 200 m recommended.)
Throttle Safe Throttle Safe (When distance and height are less than 30m, for safety concern, there is no throttle output under RTH Mode.)

Set OSD Parameters



Language	Chinese/English Page switching
Show Lat-long	Show longitude and altitude
AD Calibrate	Battery voltage calibration
OSD Pattern	OSD interface selection Default: Normal interface Fighter: HUD interface
P or N (Xin)	PAL/ NTSC selection
Show RSSI	Display the AR port's voltage, 0-3.3V is corresponding to 0-100%
Cur Man Calibrate	Current calibration %. The current sensor will adjust and input the correct power. Consumption after landing to calibrate the displayed battery capacity (MAH).
Unit	Ft(imperial)and Meter(Metric)Unit Selection;
LowPowerAlarm	There will be a flicker alarm when flight power is lower than this value.

Flight Parameters



Roll	Roll Reverse
Pitch	Pitch Reverse
Yaw	Yaw Reverse
MIX	More ways of mixed control include delta wing and V-tail wing, and Bi-motor plane, Bi-motor flying wing and butterfly brake (mixed control of 1247channel).

Gimbal roll	Norm/Inverse: Gimbal output of channel 5 left and right positive/negative compensation; CH8 : port CH5 is directly output of CH8 in
Gimbal Pitch	Norm/Inverse : Gimbal output of channel 6 up and down positive/negative compensation; CH7 Norm/ CH7 Inverse : On the basis of Gimbal output of channel 6 positive/negative compensation, add stick's value of CH7. CH7 : port CH6 is directly output of CH7 in CH9 : port CH6 is directly output of CH9 in
Gimbal roll value	Gimbal output value of channel 5 left and right compensation
Gimbal pitch value	Gimbal output value of channel 6 up and down compensation

Please connect the output of channel 5 & 6 to the camera PTZ of servos. When the flight is tilting, channel 5&6 will give an opposite compensation, so as to level the camera.

Flap mode

CH7 (Default) CH7 output is directly the CH7 input

CH7/Speed CH7 output is control by the CH7 input and Speed. When the CH7 is at the two edges, CH7 has the priority to control the flap surface. **When the CH7 is in the middle, the speed will participate in controlling the flap wing:** Either airspeed or ground speed, when the lower speed is lower than "SafeSpeed", the flap wing will be lowered proportionally. When the speed is 0, FlapMax occurs. When the speed is over SafeSpeed, Flapzero occurs.

OFF turn off the control and OSD Flap value display

Flap Max FlapMax (OSD displays F, 100% output flap quantity). When doing the commissioning, the rudder will output FlapMax value. Correct FlapMax value can be set according to the rudder position; If the flap wings move in the opposite direction, adjust the value across 50%;

Flap zero Flapzero (OSD shows F, 0% output flap quantity). When doing the commissioning, the rudder will output Flapzero value. Correct Flapzero value can be set according to the rudder position; If the flap wings move in the opposite direction, adjust the value across 50%;

If the flap servo moves different from the OSD "Flap value"(0-100%), there is no inverse option, you can adjust Flapzero & Flapmax one over 50% and one lower than 50% ,for example setting (25%、 57%) to (75%、 25%) will make the servo moves a different direction. Firstly adjust the parameters by OSD , then check CH7 of radio TX, set CH7 's **manual control's reverse** through radio

Attention: The flap is an aerofoil movable device on the edge of the flight. It can deflect or slide downward, which increases the lift force when flying. Flap wing output can release and retract slowly automatically (1.5s).It is advised to use a three section switch to control the flap wing so as to avoid accident. **When install the servos, please adjust the CH7 to make the "flap/brake value "on the OSD is 100% (zero point),then install a level rudder surface.**

As the design of the aircraft shape, some aircraft may nod when lower the flap.

As most of the ailerons are on the outer side, when channel 1/7 mix control, the flap movement may cause the left and right side of the flight uneven.

Under the balance mode, uneven torque can be compensated by Autopilot. But under manual mode may lead to accidents. Test the rudder quantity well when using the flap, keep an eye on the flap/brake control value; Use the CH7 to control the flap. Add speed control after finishing testing the Flap max/Flap zero.

Butterfly brake



When the Mix (KEY4) is set to "Butterfly FW (Flying) "mix control. Use four rudder surfaces to control the roll, pitch, direction and brake (slow down).

Two control surfaces on the left wing. The other two are on the right wing. The four surfaces are connected to the output places of channel **1, 4, 7, 8 in order**.

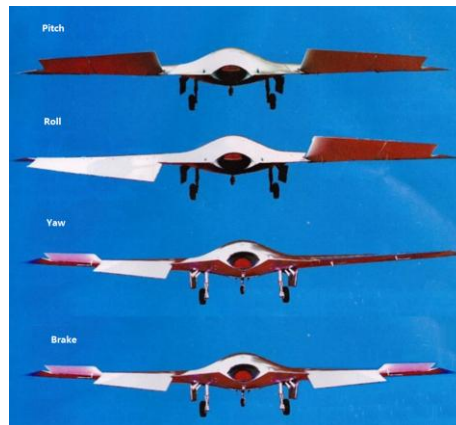

Turn the aileron stick to the left, then the two surfaces on the left lift up and the two surfaces on the right go down.

Lower the lifting stick, then the two surfaces on the left lift up and the two surfaces on the right lift up too.

Turn the direction stick to the left, then the outer surface will lift up and the inner surface goes down. There will be no movement on the right (Increase the resistance on the left, so as to make the flight turn left)

CH7 controls butterfly brake. The outer surface on the left will lift up and the surface on the right goes down. The outer surface will lift up.

Brake Ctl

CH7 (default): CH7 controls the rudder amounts of brake.

InnerBrake Max

Inner Brake Max: It is the maximum position at the two control surfaces in **inner**

side when it brakes (OSD displays F, 100% output brake quantity). When this item gets into the adjusting, the servos will output the adjusting value, Correct InnerBrake value can be set according to the rudder position.

OuterBrake Max

Outer Brake Max: It is the maximum position at the two control surfaces in **outer** side when it brakes (OSD displays F, 100% output brake quantity). When this item gets into the adjusting, the servos will output the adjusting value, Correct OuterBrake value can be set according to the rudder position.

Attention: The mixed control of butterfly brake aims to let the fly wings change its direction smoothly without aileron inclining, avoiding stall spinning. When install the servos, please adjust the CH7 to make OSD display "flap/brake value" is F 0% (zero point) status.

Since the inner torque is different from the outer torque, generally, OuterBrake Max and InnerBrake Max should be set one over 50% and one lower than 50%, and make the (OuterBrake-50%) set about a half of (InnerBrake-50%), for example, OuterBrake is set 65%(65%-50%=15%), the InnerBrake is set 20%(20% - 50% = -30%). If the wings can't yaw left and right smoothly, these two values can be adjusted.

CH7 controls brake. It increases the resistance flying, but no extra lift force. Generally it is used in rectilinear flight and landing. Please keep an eye on the value of flap/brake control displayed on the OSD.

Fence Area Set



Switching to CH5 > 50% and 30% < CH6 < 70%, within rectangle area and above safe height it is Balance Mode, otherwise it switches to RTH mode.

Fence Mode

Fence Mode , "ON" or "OFF"

North Dist

North Distance(m)

East Dist

East Distance(m)

South Dist

South Distance(m)

West Dist

West Distance(m)

Safe Height

Set Height(m)

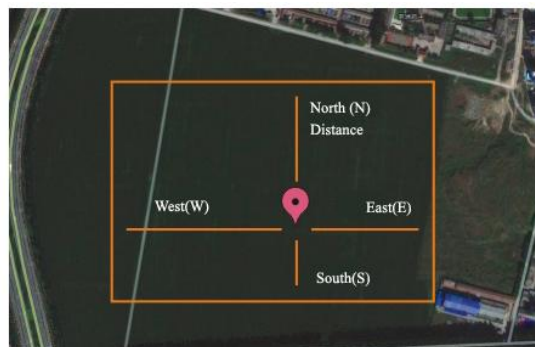

Way Point Set

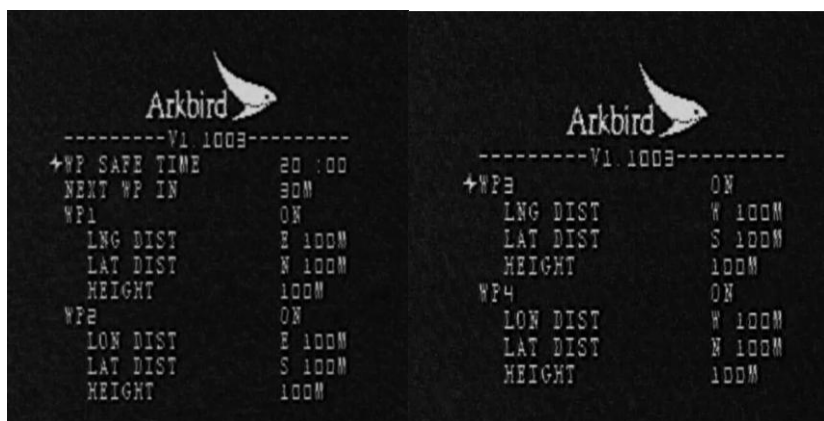

Set four way points (WP1~WP4), allow to turn on/off separately.

Set Custom Mode as Way Point Mode (CH5 > 50% and 30 %< CH6< 70%). The plane will fly in a loop upon the sequence of 1 to 4, skip the waypoint turned off, and return to home while over the safe time.

WP safe time -----WP safe time.
Returning to home if reaches the safe time. Re-timing only next power-on.

WP1 -----WP 1 On/Off
Lng Dist -----Waypoint 1 East-West distance away from Home (m)
“>” means East and “<” means West.
Lat Dist -----Waypoint 1 South-North distance away from Home (m) “≍” means South and “≎” means North
Height -----Waypoint 1 Height(m)

WP2 -----WP 2 On/Off
Lng Dist -----Waypoint 2 East-West distance away from Home (m)
“>” means East and “<” means West
Lat Dist -----Waypoint 2 South-North distance away from Home (m)
“≍” means South and “≎” means North
Height -----Waypoint 2 Height(m)

WP3 -----WP 3 On/Off
Lng Dist -----Waypoint 3 East-West distance away from Home (m)
“>” means East and “<” means West
Lat Dist -----Waypoint 3 South-North distance away from Home (m) “≍” means South and “≎” means North
Height -----Waypoint 3 Height(m)

WP4 -----WP 4 On/Off
Lng Dist -----Waypoint 4 East-West distance away from Home (m)
“>” means East and “<” means West
Lat Dist -----Waypoint 4 South-North distance away from Home (m) “≍” means South and

Height

“≡” means North

-----Waypoint 4 Height(m)



10 Balance Mode and RTH Adjustment (Very Important)

Arkbird's default parameters will be ok for most plane types. But if the most ideal situation expected, please refer to the following methods:

First time installation, do a **neutral point alignment**. Plane shall be put paralleled to the ground before neutral point check, moving aileron stick left and right to get start. (Refer to CTL menu)

Roll the plane to right and left 45 degree after neutral point check to see if OSD horizon line tilts accordingly and quickly.

Please fly on default and record OSD video on the ground. Observe the attitude through OSD and adjust parameters.

Adjusting Balance Mode:

Purpose: Stick and SUB-TRIM back to center, plane can be able to flight levelly.

1. Please increase control value ("ctl" in CTL menu) or plane's control surface when the stability not good enough (drift even stick back to center), and decrease it when the plane swings.

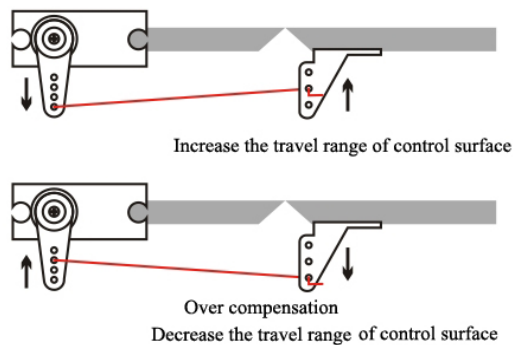

2. If plane pitches up or down when stick back to center, please adjust the "elevate angle" value (Do not adjust through SUB-TRIM, otherwise RTH Mode won't be precise.)

Adjusting Return to Home Mode:

1. Switch to RTH Mode, Important parameters “RTH Angle,” “Roll Control Value,” “Pitch Control Value,” and “Throttle Control Value” shown on OSD shall be checked all the time.

Flying to certain height, switch to RTH Mode and check if these data are appropriate.

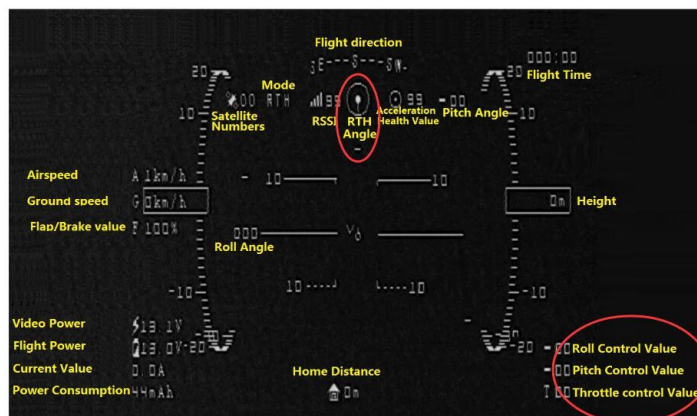

2. Adjust RTH parameters referring to these values. If the roll angle is too small to return promptly, please increase the **Max Roll**. If the turning is too fast so that the RTH line is “S” sharp, decrease the Max Roll and **increase Rudder control (Yaw ctl)**
3. Adjust **Max Up** and **Max Down** to make plane pitch up and down smoothly. (Too prompt or slow are improper)
4. Based on how far and high expect to fly, adjust **safe height** as high as possible (If fly far than 2km, please adjust this value more than 150m). Please set cruise speed as “**Safe speed**” in RTH menu.

11 FAQ and Solutions:

- ★When switching to Balance Mode, the elevator will lift up a bit because the “Elevate Angle in a level flight” in the menu is defaulted as 5°. Which means the plane will rise a bit in a level flight to ensure a level route.
- ★If the CH1 has touched the edge but you cannot enter the menu, please check if the route setup is too small on the remote control.
- ★It’s normal when the direction of compass and return arrow is inaccurate while testing on the ground. The data will be calibrated by GPS in 10s after the plane takes off.

12 Other FAQ:

Q: There is no OSD / OSD is incomplete

A: Check the wiring, restart the power, check if the camera is turned on, to see if the VDLED flashes fast.

If there shows OSD but incomplete, check PAL/ NTSC signal custom option or change display device, some USB-AV card output is incomplete

Q: Cannot locate home, displaying “Waiting GPS Home”

A: Seeing OSD “Waiting GPS Home” proves GPS wiring is OK, otherwise, please check GPS wiring.

GPS’s white antenna shall face up; keep GPS away from Video TX and Camera. Some inferior Video TX’s antenna will affect GPS, too. You can try to remove the casing of GPS, or put a layer of tin foil paper under GPS to enhance the performance.

GPS can only work Outdoors, First time about 5-10 minutes, next power on of the same day it would take less than 10seconds to locate.

Q: Plane tilts under Balance Mode / Manual Mode, can I adjust the radio TRIM

A: First time installation, do a **neutral point alignment**. Radio stick and SUB-TRIM back to center, adjust plane’s CG and travel angle to make plane balanced.

Arkbird can produce compensation when CG & travel angle is not appropriate, but it is not mechanical stable, there would be hidden trouble under RTH mode. So firstly make sure plane can fly stably in horizontal under Manual Mode.

Q: Inaccurate Return-To-Home

A: Adjust remote control rudder angle to 100% and sub-trim back to center. Check carefully in reference to the “Debugging Skills for Balance and RTH Mode” chapter of our instructions.

Make ground video recordings. When switching to RTH or other autonomous flight modes, Roll/ Pitch inclination value and throttle control value will be shown at the bottom right corner of OSD. These data will tell you if the control values are proper and will help you judge which parameter needs to be sub-trimmed.

13 Attentions:



Please read through carefully:

1. The design purpose of autopilot is to keep balance of flight, it is not able to manipulate plane or prevent stall. You must have sufficient experiences of fixed wing to control the flight.
2. The autopilot is only for small-scale RC model. For safety concern, please do not install in plane for aerial photography which might fly over crowd.
3. Please install the autopilot depends on your demands and check the condition before flying every time.
4. Any equipments and electric products on the plane couldn’t be completely reliable, please using this system following the instruction. The system provider is not responsible for any direct or indirect loss and consequence caused by using this product.

